

# COMPETENCE 730 E-m

**AEG**

Der umschaltbare Elektro-Einbauherd

La cuisinière électrique encastrable  
multi-cuisson

The Convertible Build-In Electric Cooker

Gebrauchsanweisung

Mode d'emploi

Operating Instructions

**AUS**  
**ERFAHRUNG**  
**GUT**

## Hello

Allow me to introduce myself: I am your new AEG cooking appliance. From now on, I should like to make boiling and baking more pleasurable for you. Not simply because of my attractive appearance, but also thanks to my "intrinsic qualities". I am economical in terms of energy consumption, easy to operate, and simple to care for. If you carefully read and follow my operating instructions before first use, you are sure to experience a good deal of joy when using me to boil, bake, roast, and grill your food.



# Contents

<b>Safety instructions</b>	
For the installer	88
For the user	88/89
<b>Appliance description</b>	
Features	90
<b>First use</b>	
Operating the switches	91
Precleaning the oven	91
<b>Hobs</b>	
Hob user protection	92
Features	93-96
General	97
Operating the hobs	98/99
<b>Variable oven</b>	
General	100
Fume extraction	100
Heating modes	101
Shelf levels	102
Switching on and off	103
Oven space divider for <b>all</b> heating modes	104/105
Baking	106-108
Roasting and steaming	108-110
Flat grilling	111/112
Special preparation methods with hot air	
- Menu-cooking	113
- Defrosting	114
- Bottling	115
<b>Cleaning and care</b>	
Cooking area	116-119
Oven	119-122
<b>Special accessories</b>	123
<b>What to do if . . .</b>	124
<b>Customer services</b>	125

## Safety instructions

### **For the installer**

The safety requirements oblige manufacturers to give the following instructions:

For installation in a kitchen unit, my attached installation instructions must be noted.

### **For the user**

- **Should any fractures, cracks, or other defects appear in my high-grade glass-ceramic oven ceiling, please immediately stop using my oven.**

**For your additional safety against any subsequent switch-on, remove my cooker fuses or switch off the automatic safety system. Please notify promptly the service centre covering your area.**

- **If you use my oven space divider, the heated oven space divider should only be placed in my oven complete (lower part with heating element and cover).**
- When you use me to prepare your food, my hobs and/or the oven door become hot. Therefore keep small children well away from me.
- **This especially applies when you are grilling or pyrolytically cleaning my oven (if available).**
- Overheated fats and oils rapidly ignite. When using me to prepare food in fat or oil (e.g. chipped potatoes), please remain nearby.
- Do not use me to heat your room.
- Take care when connecting electrical appliances to plug sockets in the cooker vicinity. Connection leads should not come within reach of hot hobs/cooking zones or get trapped under the hot oven door.
- To avoid damage to my glass-ceramic surface, you should not use my cooking area as a storage area.
- **Do not place any hot frying pans or saucepans on the edge of the cooking area as this can cause damage.**
- Never cover my cooking surface with protective foil. **This can cause damage.**
- The glowing red heat of my cooking zones can shine out over the edge of the marked zone, according to the angle at which you look at it.
- My glass-ceramic cooking area (**where featured**) is extremely resistant, though not unbreakable. It may be damaged by any sharp or hard objects falling on to the cooking surface. Should any fractures, cracks, or other defects appear, I must be separated from the mains supply by the device required on the fixed wiring side. Before doing so, please switch my 4 hob switches to 0.
- Never line my oven floor with aluminium foil and never place any pan, pot, etc. on my floor, since the oven enamel will otherwise be damaged by the heat congestion caused.
- If the oven is fitted with a cooling fan, it can happen that this continues to run after the oven has been switched off (with all switches in the "0" or "Off" position). The fan can also switch itself on as a result of residual warmth in the oven. If so, it will switch itself off again automatically.
- Fruit juices dripping from the oven sheet leave stains that you will find hard to remove.
- I comply with radio interference suppression specifications EN 55014 (previously EC Directive 87/308/ECC) and as appropriate with EN 60555 relating to the Retroactive Effect on the Mains Supply.

## Appliance description

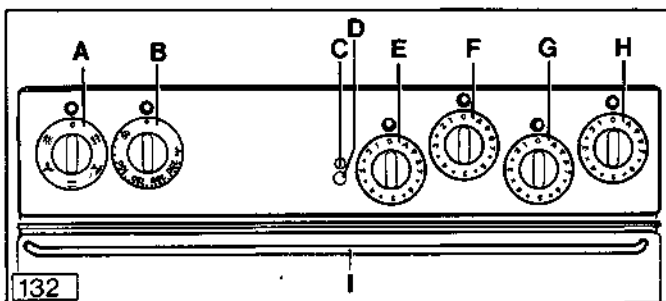

### Features

- A** Switch for oven cooking functions with pilot lamp (amber) lights up when my oven is switched on
- B** Oven pilot lamp (red) lights up when my oven is heating
- C** Pilot lamp (red) for user protection display
- D** User protection button
- E** Switch for front LH Automatic hob, with pilot lamp (amber)
- F** Switch for rear LH Automatic hob, with pilot lamp (amber)
- G** Switch for front RH Automatic hob, with pilot lamp (amber)
- H** Switch for rear RH Automatic hob, with pilot lamp (amber)
- I** Handle for opening my oven door

## First use

My switch A can be turned both right and left from any position. Further information on this feature is given in the "Hobs" and "Oven" sections.

You must be a little more careful with my switch B for the oven temperatures. You can only turn it clockwise (to the right) as far as the grilling symbol . It is reset by turning to left.

The same also applies to my switches, E, F, G, and H for the **automatic** hobs. You can also only turn these switches clockwise (to the right) to their fullest extent.

**When you switch on one of my switches, a pilot lamp (amber) lights up above.**

Before using my oven for the first time, please clean all accessories (baking sheet, drip-pan, combination grid, etc.) with warm washing-up liquid suds. Then switch my heating mode switch to the top and bottom heat symbol  and my temperature switch to 250°C and thus operate my empty oven with the door closed if possible for 1 hour.

The odour occurring is not harmful to the health. **To avoid any nuisance, you should ventilate your room well during this time.** When I have cooled down, please also clean my oven with warm washing-up liquid suds.

## Operating the switches

## Precleaning the oven

### **Hob user protection**

The user protection feature is intended to protect my hobs against any unauthorized use (child safety through two independent operations).

3 hours after the last operation of a hob switch, all hobs are automatically switched off.

### **Switching on hobs**

Owing to the safety precautions noted, please proceed as follows when using my hobs:

- Press user protection button. Red pilot lamp comes on.
- Switch on required hob(s) immediately thereafter.

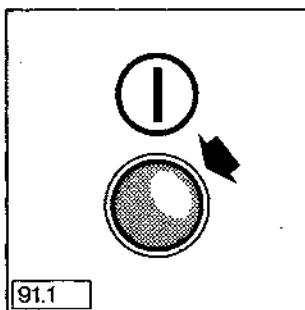

Important: If you should ever accidentally not keep to the sequence of firstly pressing the user protection button and secondly switching on the hob, please turn the hob switch back to "0" and start again. If the cooking cycle is ever to last for more than 3 hours, you can turn one of my hobs (preferably one of the ones you are not using) on and off again quickly. This extends the cooking time by a further 3 hours. It is best to do this after a certain time, e. g. after an hour or two.

### **Switching off hobs**

When cooking is to be ended, switch my hob switch(es) to the zero position.



## Hobs

Depending on the kind of cooking hob I am fitted with, you will find different kinds of hotplates:

### ■ High-speed hob

My cast-iron hotplate differs from ordinary cast-iron hotplates because it is more efficient, and thus can cook more quickly. It is marked by a small red dot – this disappears after a short time through being constantly warmed up and cleaned. It is adjusted in the usual way.

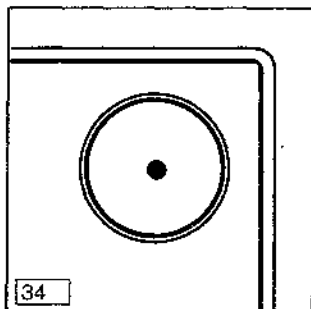

The following are arranged under the extremely temperature-resistant glass-ceramic cooking hob according to model:

### ■ Single-ring cooking zones

This cooking zone is adjusted solely by means of the switches fitted in the switch panel.

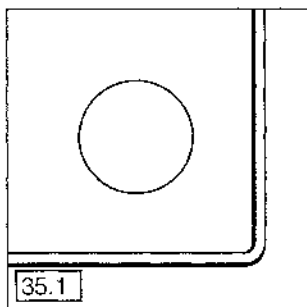

## Features

### Glass-ceramic hob

### ■ Double-ring cooking zones

The second ring of the cooking zone can only be turned on when the relevant switch on the switch panel is also on. The **touch-button**  in the glass-ceramic hob is pressed lightly and the red control lamp comes on. Both heating circuits are **adjusted** and **turned off** by the switch on the switch panel.

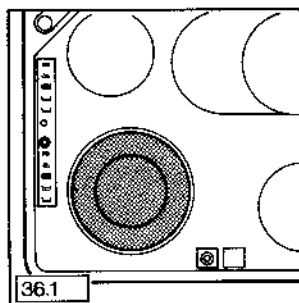

### ■ Frying zone

My heating is arranged in a circle and is controlled by the relevant switch on the switch panel, while the heating for the roasting zone is turned on by lightly touching the **touch-button**  in the glass-ceramic hob. Both heating circuits are **turned off** by means of the switch in the switch panel.

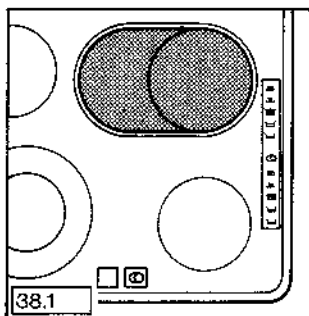



### ■ Halogen cooking zone

This cooking zone is heated by a special high-intensity halogen lamp, which is controlled by the relevant switch in the switch panel.

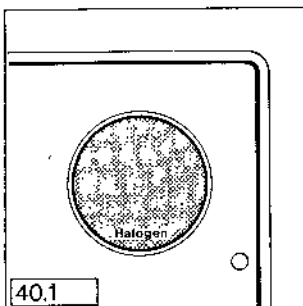
**Caution:** Do not stare hard at the halogen lamps of the radiant cooking hobs.



### ■ Warming zone

My zone for keeping plates or meals warm is switched on by lightly touching the **touch-button** , and **switched off** again by touching it again .

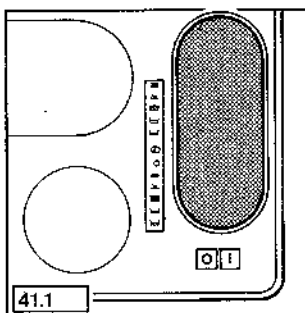



### ■ User guidance

For each of my cooking zones there are five symbols with control lights that show at what setting the various cooking processes can be done.

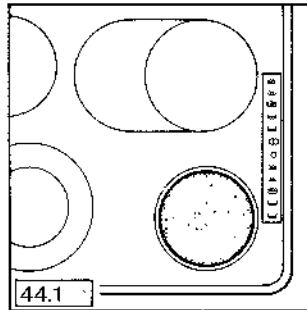
The symbols signify:



 Heating up, frying at high temperature

 Frying

 Steaming/Boiling

 Parboiling

 Melting

Please also follow the table on setting the automatic cooking zones.

### ■ Residual heat indicator

For each of my glass-ceramic cooking zones there is a control light, on the left or the right in the glass-ceramic hob, which lights up if the cooking zone is hot. As soon as the cooking zone cools down the light goes out.

### ■ Escape of steam and fumes from the oven

The fumes from my oven can escape through the openings at the back of my hob. You will find more details in the section on fume outlet from the oven.

**General  
- Cookware**

The better the pot, the better the cooking result.

- You can tell good cookware by the pot bottom and not by the material from which the pot is made.
- The bottom should be as thick and flat as possible. It should also not be rough (as e.g. on cast-iron pots), since scratches arise when the pot is shifted.
- Use **high-sided pots for dishes requiring plenty of liquid, and the nothing can boil over.**
- Prevent enamelled pots or frying pans from boiling dry. Their bottoms can be destroyed if this happens and then they scratch the cooking area when they are shifted. Pots and frying pan bottoms with sharp edges also have a scouring effect.

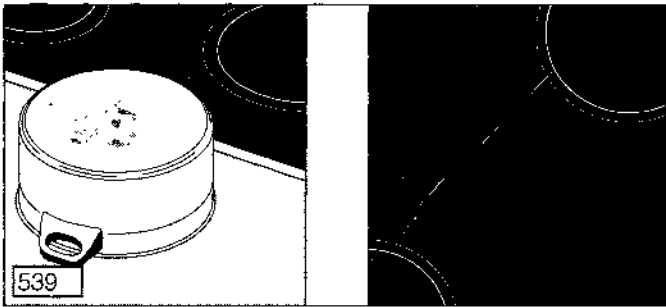

- The **pot bottom and the hob** must be of equal size. Please make sure that your cookware stands in the centre of the hob. My hobs should always be clean, since soiled hobs and cookware bottoms not only damage my glass-ceramic cooking area (if available), but also increase power consumption.

Make good use of the afterheat by switching off the hob just before cooking ends.

You waste energy and/or cooking takes longer if . . .

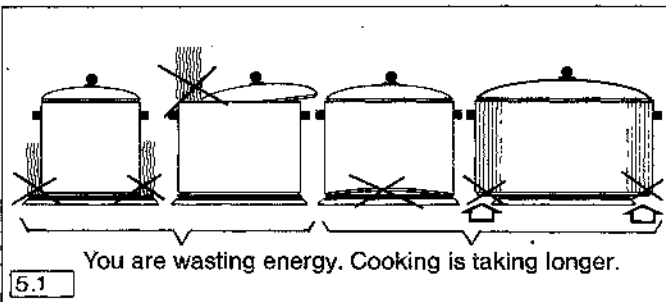

Pot too small

Pot lid not closed

Pot bottom uneven

Pot too large (glass-ceramic)

**Operating the cooking zones – beforehand**

After switching on a cooking zone, you will hear me buzz. This is a feature of my radiant heating system not in any way impair my operation!

**Never** place food in aluminium foil or plastic containers on my hot cooking area, since that will have an extremely detrimental effect on the glass-ceramic cooking surface!

**– Boiling/ frying on the automatic hob**

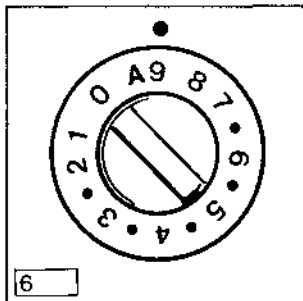

**Without the automatic system**

You can also use my automatic hobs without the automatic system. You should then switch me on only as far as **setting 9**.

When **starting to fry**, set the switch referring to the hob to 9 until the fat is hot. Then place the food to be fried in the pan and turn the switch back to 6 or higher as necessary.

When **starting to boil**, set the switch referring to the hob to 9. To simmer, turn the switch back to 1 to 5 as necessary.

Intermediate settings, e. g. 3 • (or • 2 only with electronic indicator), are at all times possible.

**With the automatic system**

When **starting to boil** within the 1-8 region (not on setting 9), **my automatic system** relieves you of the need to switch over to my simmering level.







**Turn the knob to the right as far as it will go, to Letter A** (the relevant pilot light comes on, but **only if I have an electronic display**).

When you let go of the knob, it will jump back to setting 9. Then, turn the knob back to the required **simmering level (1 to 8)**.

**My automatic system selects for you the boiling-up time at the start of cooking and then itself switches back the power corresponding to the simmering setting selected.**

The automatic system and/or the hob is switched off by turning to 0. The following table shows you examples of the suitability of switch settings 1 to 9.

**Boiling/frying table for the automatic hob**

Switch setting		Suitable for
 9	<b>Boiling up</b>	Boiling up large quantities of water. Boiling noodles
7-8	<b>Fast frying</b>	Deep fat frying of chipped potatoes. Fast frying of meat, e.g. goulash. Fritting of e.g. potatoes. Frying fillets, steaks
 6-7	<b>Slow frying</b>	Frying of meat, schnitzels, Cordon Bleu, cutlets, pancakes, meatballs. Making roux. Light frying of sausages, liver, eggs. Deep-frying of doughnuts
 4-5	<b>Cooking</b>	Cooking large quantities of food, single-portion meals and soups. Steaming of potatoes. Making gravy
 3-4	<b>Steaming</b>	Steaming of vegetables or stewing of meat. Making rice pudding
 2-3	<b>Creeping</b>	Creeping of rice and milk puddings (stir occasionally) <sup>1)</sup> . Steaming of small quantities of potatoes or vegetables. Heating of ready meals
 1-2	<b>Melting</b>	Omelette, custard, sauce hollandaise. Keeping food warm. Melting of butter, chocolate, gelatine
0		Afterheat, off-position

<sup>1)</sup> only with induction hobs

## Oven

### General

Before using for the first time, please note the section describing precleaning of the oven.

You can operate my oven with either traditional top and bottom heat, hot air, or in two (three) grilling modes, exactly as you wish and according to your recipe, since I have the practical type of convertible oven. You will find more detailed instructions under the methods of preparation and the safety instructions for the user.

### - Fume outlet

My fume outlet in the cooking area (see illustration) can be opened or closed with the push-button. Please press my push-button only when the hobs are not operational to exclude the possibility of burning. Should you operate my push-button when the hobs are hot, however, we recommend you to use an object such as e. g. a cooking spoon to open or close.

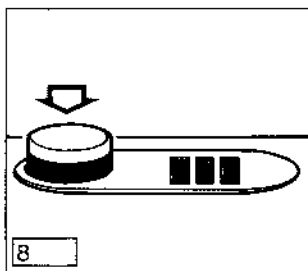

**This enables you to control the humidity in my oven during baking or roasting and thus save yourself energy or even the need to add water.**

Closed: **Push-button released**, red edge visible

Open: **Push-button pressed**

During preheating and during the first third of the time when baking bread or breadrolls, you can close my fume outlet to obtain better rising and browning.

During roasting, you should also keep my fume outlet closed, unless you want to achieve a crispy meat surface, as e. g. during the grilling of poultry.

**Please follow the tables on baking and/or roasting.**



My cooking function options:

■ Top and bottom heat



In this mode, the heat uniformly radiates from above and below. Your roast turns out crisp and succulent. You should always roast or bake only at one level, however, to ensure uniform application of heat.

■ Hot air



A fan ensures continuous circulation of uniformly hot air. Your cake receives heat the same intensity of heat from all sides, enabling you to roast, bake, and stew at three levels. You save time and also power owing to the low temperatures used.

■ Infratherm grilling



The grill combination and hot air are together in action! This enables you to grill or roast larger joints of meat and poultry at one level. This cooking function is also ideal for “au gratin” cooking and crisping-over.

■ Flat grilling



The grill attachment is fully utilized in this mode, e.g. for succulent steaks and schnitzels or for slices of halibut and salmon.

■ Double-circuit grill



Use my large grilling area  for high-speed grilling or toasting of larger quantities.

For smaller quantities, e.g. grilled steaks or possibly 4 slices of toast, it is sufficient to switch on my small grilling area (economy grill) .

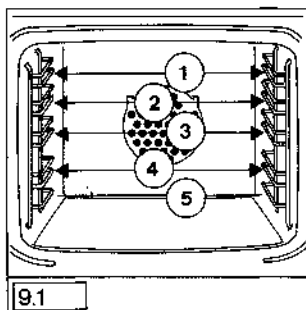

### - Shelf levels

Both sides of my oven have a shelf level grid. These grids can take a grid, drip-pan, or baking sheet at 5 levels.



### - Grease filter

The grease filter supplied protects my fan against soiling. **It must always be inserted when**

- I am heated by hot air  and meat is being roasted in uncovered pans or on the grid (i.e. do not insert when baking!),
- during infratherm grilling  in the drip-pan or grilling in an uncovered pan.

### Inserting grease filter

Hold the grease filter by the grip and insert both retaining rings (see illustrations) from above downwards into the openings on the oven rear wall.

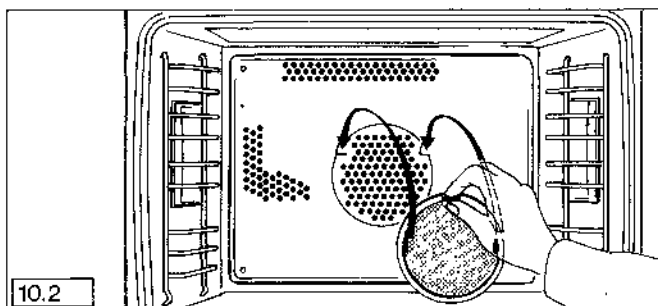

Make sure that the grease filter exactly closes the opening.

**Switch my oven off before you start cleaning it, i.e. all switches for the oven have to be at the "0" or "Off" position.**

The grease filter has to be cleaned as and when necessary. To do this, take hold of it by the handle and pull it out **upwards** from the back wall of the oven.

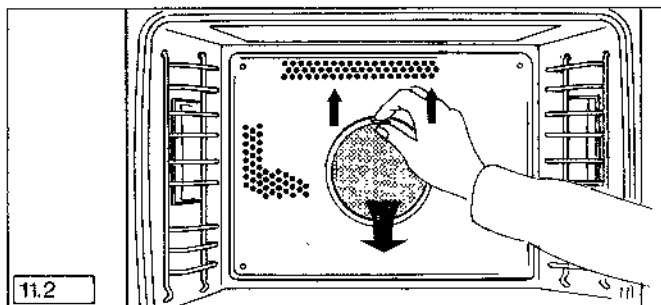

Boil it briefly in the same cleaning product as you use in the dish-washing machine, or with soft soap. Fit it back in – **but not until it is dry** – from **on top** into the openings in the rear wall of the oven.

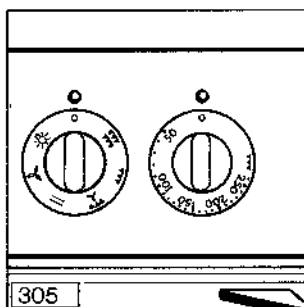

First decide with which heating mode you want to use my oven. Then set my switches – heating modes – to the corresponding symbol e.g.  for hot air. Then turn my oven temperature switch to the necessary temperature. Turn this switch to the right to a higher temperature. The red pilot lamp shows as long as the oven is being heated and goes out as soon as the set temperature is attained. It comes back on when the oven is being reheated.

If you preheat my oven (see corresponding note in the Tables), do not insert the food to be baked/roasted until the red pilot lamp first goes out. To utilize the afterheat, you should switch off my oven around 5-10 minutes before the end of the baking/roasting time. To do this, turn my oven temperature switch to the left to the Off position and the heating mode switch to 0.

## **Cleaning the grease filter**

### **– Switching on and off**

## Oven space divider

My oven size (with oven space divider) is arranged for everyday use.

This means that you can **roast** joints or poultry up to a size of **around 2 kg** and **bake at max. 2 levels**.

When you use me in this way, you make the following savings in comparison with conventional ovens:

Energy, and my cleaning is also easier for you, since you can detach the cover of my heated oven space divider for cleaning. While you are cooking in my upper oven, you can use the lower part for warming of crockery or for the storage of unused accessories.

The oven space divider can be inserted in **all** operation modes!

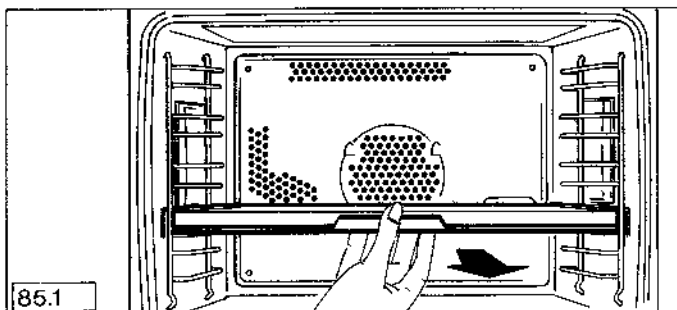

If you are roasting large joints or poultry – such as a goose or turkey – or baking at 3 levels, detach my heated oven space divider to enlarge my oven.

If you remove my heated oven space divider to enlarge my oven or for cleaning, **set my cooking function switch and oven temperature switch to 0 and the Off position respectively.** To remove my oven space divider, slightly lift this **forward (front side of oven)** and at the same time **pull it forwards out of my oven!**

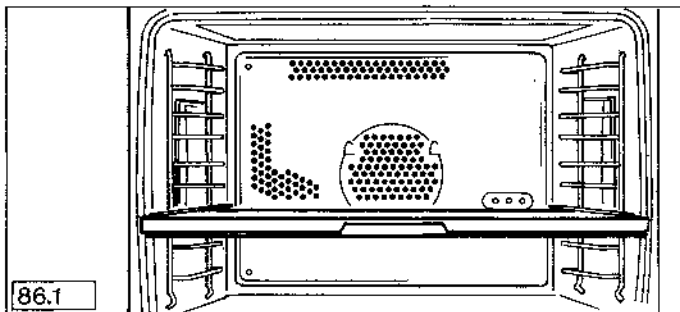

For your safety, my plug socket on the oven back panel is automatically closed when you take out the heated oven space divider.

**Important: Never insert my heated oven space divider without a cover!**

**When inserting it, make sure that the oven space divider is pushed right in!**

**To remove the oven space divider**

**You should also be aware of the following**

**Baking  
– with top/  
bottom heat**



■ **Bakeware:**

You can use me to bake cakes either in baking forms or on baking sheets. The material from which the bakeware is made is extremely important.

The most important differences:

1. Black sheet baking forms, coated baking forms, or gold baking forms are the best, since they absorb heat and transfer it to the dough most rapidly, implying for you shorter baking times and lower power consumption.
2. White sheet baking forms reflect the heat, i.e. they repel it. Cakes which you bake in such forms have a longer baking time, do not become so nicely brown, and require a longer baking time. When baking with top/bottom heat, you should therefore not use white sheet baking forms.

■ **Baking at one level**

Place the food to be baked at one level only. The flatter the pastry, the higher you should place it in my oven.

■ **Baking times and baking temperatures**

In many cases, it is not necessary to preheat me. The recommended temperatures and times given in the attached table are guidance values. Deviations may possibly occur in practice.

**Baking  
with hot air**



In this heating mode, I bake at several levels simultaneously – quickly and economically – to save you time. I also bake different cakes at the same time, e.g. fruit cakes and almond cakes. You need only make sure that the prescribed temperatures for the various items roughly coincide.

You should also take note that more steam arises when several baking sheets are inserted at any one time. This especially applies to fruit cakes. In the case of very moist fruit, e.g. damsons, therefore bake on only two sheets at most at any one time.

**If the appliance has an oven space divider, only put in 1 sheet with fruit tarts or pies.**

**When you are baking on several baking trays at once, please keep an eye on the upper tray and if necessary take it out sooner.**

■ **Baking times and temperatures**

During baking with hot air, it is also not necessary to preheat me for most types of cakes. Exceptions are indicated in the attached baking table.

If you want to bake different types of cakes at the same time, the prescribed temperatures should coincide. The baking times can be adapted by subsequent insertion or removal of items. During the initial period, the baking table will be of great assistance to you.

The recommended temperatures and times given in the attached table are guidance values. Deviations may possibly occur in practice.

When baking several cakes on baking sheets or in forms, you should prolong the time indicated in the table for one sheet or form by around 10-20 minutes.

■ **Baking at one or more levels with space divider.**

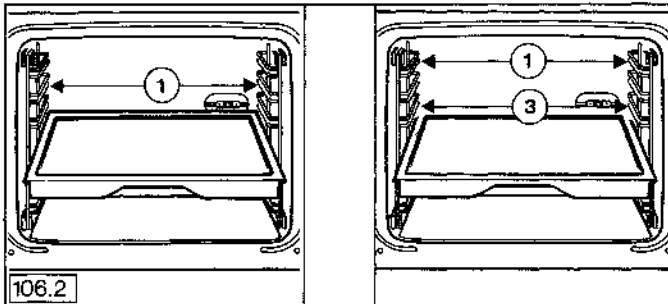

In the size-reduced oven, you can simultaneously bake on **2 baking** in the large oven.

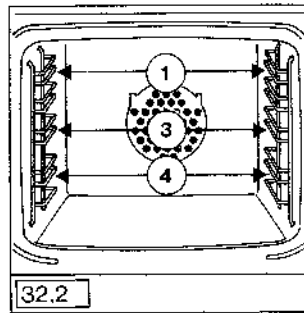
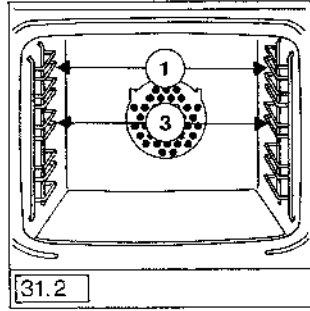
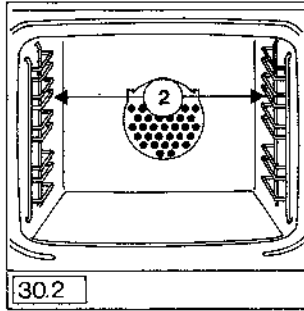

■ Baking at one or more levels



You can also simultaneously bake on 3 baking sheets.  
You can obtain additional baking sheets and grids as special accessories.

**Roasting  
and steaming  
- Heating  
modes**

■ Please choose the most favourable heating mode from my various options:

- Top/bottom heat 
- Hot air 
- Infratherm grilling 

The **bold type** in the **attached table** gives you the insertion level and temperature indications.



### ■ Recommendations

For all heating modes, the following applies:

Meat and fish should only be roasted in the oven from 1 kg weight. When using drip-pans with a grid, liquid should be added where necessary (e.g. during prolonged roasting times) so that dripping fat and meat juices do not burn.

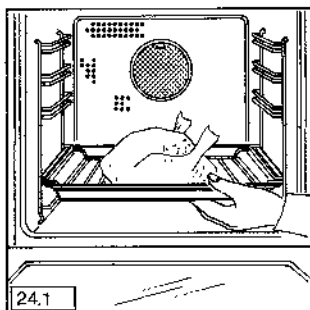

**My drip-pan can be inserted with the wire grid on top of it. This makes it easier to handle. My accessories are fitted with a special tipping mechanism to prevent them from being pulled out.**

- The larger the roast which you entrust to me, the longer must the roasting or grilling time be set. The roasting/grilling times depend on the type, quantity, and quality of the meat. In practice, deviations from the indications given in the tables and recipes may therefore arise.
- So that any evaporated liquid can be supplemented, I recommend you during the roasting time to check your meat/fish from time to time.
- After around half the cooking time, the meat/poultry should be turned so that it is uniformly browned right round.

**- Temperature, roasting/  
grilling time**

## Ovenware

Meat, poultry, and fish should be roasted in roasting pans, forms or in my drip-pan. If you use pots or forms, never place them on the floor of my oven, but on the grid, which you should insert at the 2nd or 3rd level from above depending on the size of the roast.

For roasting, we recommend you to use:

Dishes	Ovenware		Drip-pan	
	un-covered	covered	without grid	with grid
Roast pork	●			
Roast lamb	●			
Roast mutton	●			
Roast veal		●		
Roast pickled beef		●		
Braised steak		●		
Mince	●			
Duck, large	●			
Goose				●
Pork chops, 1-2 3-4	●			●
Chicken pieces, 1-2 3-4	●		●	
Turkey			●	
Small poultry	●			
Roast beef	●			
Fillet steak	●			
Game	●			
Fish	●			
Deep-frozen meat		●		



You can crisply grill all flat pieces of meat and fish which can also be fried in the pan and are not heavier than 1 kg: steaks, chops, etc. You should season large pieces of meat/fish shortly before grilling and small ones shortly afterwards.

Turn the slices of meat/fish after half the grilling time so that the slices are uniformly grilled on both sides. You need only turn flat slices and pieces once; larger round pieces should be turned several times.

**Please insert my drip-pan and combination grid together in my 2nd level from above.**

**Set my heating mode switch and my temperature switch to the flat grilling symbol  and/or .**

The indicated grilling times may only be guidance values, since, precisely during grilling, the times depend on the type and thickness of the food to be grilled and the degree of cooking.

On appliances with a double-circuit grill , you should set the grill to grill symbol  for small amounts and to symbol  for larger amounts.

**Fume opening: open**

**You can clean the drip-pan and grid more easily by soaking my drip-pan/grid in washing-up liquid suds immediately after grilling.**













**Preheat my oven 5 min., and always grill with the oven door closed. You will thereby save power.**

## Flat grilling



## Recommendations

**Flat grilling table**

Type/quantity	Shelf height for drip-pan/grid, from above in each case	Grilling time		Insert grid
		1st side	2nd side	
Pork chop, pork schnitzel, meatballs, veal schnitzel, mutton and lamb chops	2nd	8-10 min.	6- 8 min.	
Pork fillet	2nd	10-12 min.	6-10 min.	
Frying sausage	2nd	8-10 min.	6- 8 min.	
Kebab	2nd	7- 8 min.	5- 6 min.	
Fillet steaks, veal steaks	2nd	6- 7 min.	5- 6 min.	
Fillet beef, roast beef (around 1 kg)	2nd	10-12 min.	10-12 min.	
Slices of liver	2nd	3- 4 min.	2- 3 min.	
Chicken, halved (around 500 g each)	3rd*)	10-15 min. inside	10-12 min. outside	
Fish fillet	2nd	6- 7 min.	4- 5 min.	
Trout, around 200-250 g each	2nd	4- 7 min.	3- 6 min.	
Toast	2nd	2- 3 min.	2- 3 min.	
Toasted snacks	2nd	6- 8 min.		

**\*) Remove intermediate floor (if featured)!**

## – Menu-cooking in the large oven

- **When menu cooking, please remove my oven space divider** (if available).
- That is the truly amazing feature of my hot air oven. You can cook a complete menu all at once. Fish, meat, and dessert in one sequence. The fish does not taste of dessert, and the dessert does not taste of meat. Taste and smell do not mix.
- The dishes you want to cook should need roughly the same cooking temperatures.
- As soon as meat is cooked in an open vessel, please insert the **grease filter**.

Baked items indicated in the table as having around 20 °C lower temperatures can be coordinated with the meat dishes (see attached table on baking, roasting, and steaming). Differences of around 10 °C can be compensated by shorter or longer cooking times.

The **shelf height** must be selected depending on the individual foods to be cooked. Dishes with shortest cooking times should be inserted above. If several forms are to be placed above each other, a grid or drip-pan can be arbitrarily used to hold them.

### Menu example:

**Fume opening: open**

Stuffed peppers with rice and cottage cheese soufflé.

Ovenware: Fireproof forms

Shelf heights: Rice and cottage cheese soufflé  
level 5 from above  
Stuffed peppers  
level 3 from above

Heating mode: hot air

Temperature: 175-180 °C

Cooking time: around 1 hour  
10 minutes  
Afterheat: 5 minutes

**- Defrosting**

- Dishes in flat aluminium containers defrost especially well, since aluminium is a good heat conductor. For freezing and subsequent defrosting of meat and vegetable dishes, flat aluminium forms should therefore be used. For defrosting of raw and deep-frozen meat and fruit, closed, fireproof forms are especially well-suited.
- As the **shelf height**, basically the 2nd level from above should be used. For holding of forms and aluminium containers, the grid or drip-pan can be used.

**Defrosting table**

Type of foodstuff	Temperature	Time h/min.		Fume opening	
				open	closed
Deep-frozen convenience foods (1-4 servings)	200	0.40-0.50	Defrost and warm to eating temperature		●
¼ cake from sheet in aluminium foil	200	0.15-0.20	Defrosted and ready to serve		●
½ cheesecake or apple tart in aluminium foil	200	0.30-0.45	Defrosted and ready to serve		●
Bread around 500 g in aluminium foil	200	0.15 and 0.30 afterheat	Defrosted and ready to serve		●
Breadbuns	200	0.15 and 0.10 afterheat	Defrosted and ready to serve		●
Fruit, e.g. strawberries, raspberries in closed glass container	200	0.15 and 0.15 afterheat	Defrosted and ready to serve		●
Raw, frozen roast meat (e.g. 1½ kg roast pork)	180-200	2.00-2.30 (depending on meat type)	Defrosted and simultaneously roasted		●
Deep-frozen chicken, around 1000 g (cover with greaseproof paper)	50	1.00-1.15	Defrosted for roasting and grilling		●

- For bottling, use only commercially available bottling jars (jars with rubber rings and glass lids). Never use jars with screw fittings or bayonet catches or metal tins. And make sure you use fresh foodstuffs!

The oven holds 6 bottling jars of 1-1½ litres capacity.

Place 1 cup of hot water in the drip-pan so that the necessary humidity is retained in the oven.

- As the **shelf height**, use the 4th level from above. The jars should not touch, must wherever possible be filled to the same level with the same contents, and must be securely clamped.
- To **switch on**, turn my heating mode switch to hot air  and the oven temperature switch to 160 °C.

- **Fume opening: closed**

- **Keep an eye** on the food being bottled.

As soon as the liquid in the first jars (when bottling **fruit or pickled cucumbers**) **begins** to bubble (after around 45 minutes for 1-litre jars) switch off the oven, but allow the jars to stand a further 30 minutes or so – around 15 minutes for tender fruit, e.g. strawberries – in the closed oven.

When bottling **vegetables or meat**, set back my oven temperature switch to 100 °C as soon as the liquid in the first jars **begins** to bubble and allow the contents to **cook** for a further 60-90 minutes. Then switch off the oven with both my switches and allow the jars to stand a further 30 minutes in the closed oven.

## Cleaning and care

### Glass-ceramic cooking area – Principles

If you have coordinated a glass-ceramic cooking area with me, a few principles should be observed despite its special virtue of being easy-care:

**It is important to clean my cooking area every time it has been used!**

1. Never use aggressive cleaners, such as e.g. coarse scouring agents or abrasive pan cleaners.
2. Always clean the cooking area when it is slightly soiled – preferably after each use.

For this purpose, use a damp cloth and a little washing-up liquid. Then wipe the cooking area dry with a clean cloth. No cleaner residues should remain on the surface.

3. Thoroughly clean the whole cooking area once a week. For this purpose, use "Sido! Stainless Steel Gloss", "Steel-Fix", or "WK-Top".

Then thoroughly clean the whole cooking area with clean water and wipe dry with a clean cloth. Please make sure that no cleaner residues remain on the surface! The cooking area may otherwise be damaged!

4. **Only use the recommended cleaning products!**

### – Special soiling

#### Boiled-over food

First soften with a wet cloth and then remove the food residues with a **glass or razor-blade scraper**. **Take care to avoid injuring yourself!**

Then clean the cooking area as described under 3.

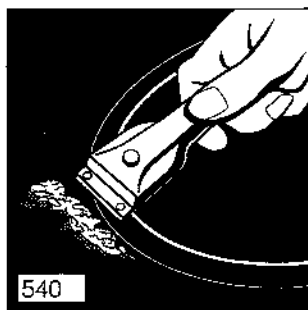



### **Burned-on sugar, melted plastic**

Remove this at once – when still hot – with a glass scraper, as otherwise permanent damage could result. Then clean the cooking area as described under 3.

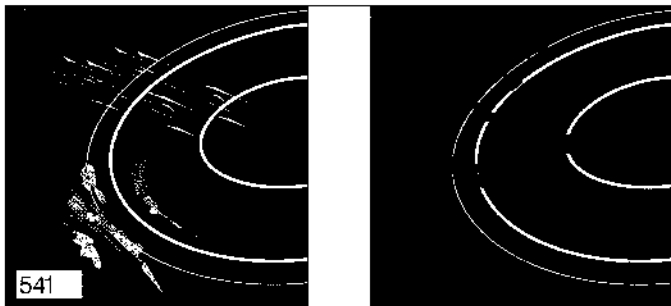

You can prevent damage due to sugar or sugar-containing foods by caring for your glass-ceramic cooking area with Collo-Profi or Cerafix.

### **Stains**

(Scale stains or mother-of-pearl-like glossy stains, or discolourations with a metallic glint (saucepan rubbings), formed during cooking) are best removed when the hobs are still warm (not hot). For this purpose, also use "Sidol Stainless Steel Gloss", "Steel-Fix", or "WK-Top". Proceed exactly as described under 3.

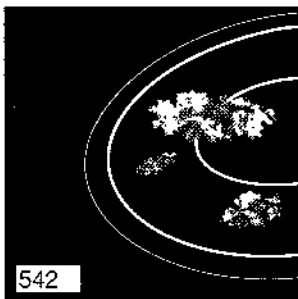

### **Grains of sand or grit**

which fall on to the cooking area may cause scratches when pots are moved about. Please make sure therefore that no grains of sand or grit remain on the cooking area.

**- Special  
soiling**

**Sanded finish**

The use of aggressive cleaning products and rough-bottomed saucepans gives the surface a sanded finish after a time, and dark patches will appear.

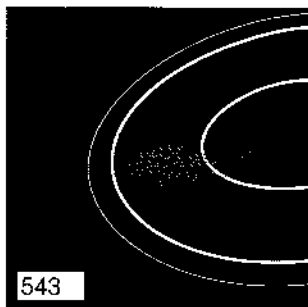

You can obtain suitable cleaners, cleansing agents, and a glass scraper from the AEG Service Centre.

**Hob unit with  
cast iron hobs**

Please clean heavy soiling of the cast iron hobs with a fine scouring agent or sponge. Then lightly heat and allow to dry.

Please note that cleaners are unsuitable for the stainless steel edge of the cast iron hob and stainless steel hob unit, since they cause scratches.

Thermal loading during cooking may cause slight yellowing of the stainless steel edge and stainless steel hob unit. This depends on the physical nature of the material (its tendency to tarnish).

These discolorations can be easily removed with "WK-Top" or "Steelfix".

**In order to avoid the danger of corrosion between the edge of the hob and the hob unit, please note the following instructions:**

- Never lay any wet saucepan lids e.g. if steam has condensed inside them) on my hobs.
- Only put pots or pans on my hobs if they are **dry underneath**.
- Make sure that the pot or pan is **always bigger** than the diameter of my hob (**never smaller**), so that no food can boil over and run down onto my surface.
- After cleaning my hobs, heat them up for a short time to dry the surface out.

**Make sure that my hob covers or my decorative lids (if I have any) are dry on the inside when you place them on my hobs or close them.**

To care for my hobs, you can occasionally use a little sewing-machine oil (finally polish with paper) or other cleaners and cleansing agents, such as Collo-Elektrol, which you can obtain from the AEG Service Centre.

Never use butter, bacon, or the like!

■ **Normal cleaning**

Clean my oven after each use. This makes fat splashes easiest to remove. For stubborn soiling, use K2r Oven Cleaner, Huy, Collo Grill Cleaner, or Express Oven Cleaner.

**To clean my glass-ceramic ceiling (if available), you can safely use oven spray or, for heavy soiling, a glass scraper.**

Then wipe with clean water to remove all cleaner residues. Never use aggressive cleaners, such as e. g. coarse scouring agents or abrasive pan cleaners. You can obtain suitable cleaners and cleansing agents from the AEG Service Centre.

You can **illuminate** my oven for cleaning. To do this, turn my oven switch or my heating mode switch to the lamp position .

■ **Thorough cleaning**

For thorough cleaning, you can **detach various parts:**

## Oven

## Oven lighting

### **Cleaning my heated oven space divider**

My heated oven space divider should be removed for cleaning. The upper cover can be pulled forwards and cleaned in a sink.

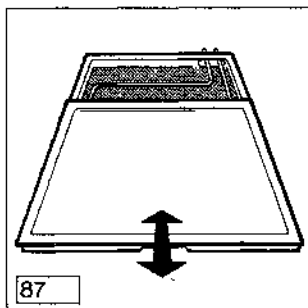

**Important: Never hold or place my heating element and the lower part of my oven space divider in water or in a dishwasher!**

After cleaning and drying, especially the heating element contacts, re-assemble the oven space divider and slide it into the appropriate shelf level provided in my oven.

**Important: My heated oven space divider may only be inserted in my oven complete (lower part with heating element and cover)!**

### **Cleaning and replacing the light bulb(s)**

**Important: Switch off my fuses on the fixed wiring side (safety box) (remove screw-in fuses from holder).**

To clean the glass covers and change my light bulb(s), **the glass cover should only be removed by hand!**

**Important: Please never use any tools!**

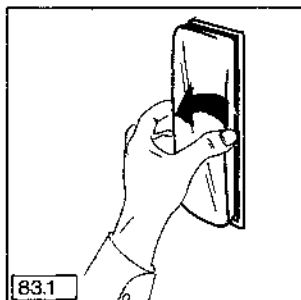

**After changing the light bulb(s), clip the protective glass cover back in position.**

## Detaching the oven door

### ■ To detach the door

1. Lift the door catch on both door hinges (see illustration).
2. Lift the door in the direction of closure and pull out forwards (**grip at the sides – do not pull on the door handle!**).

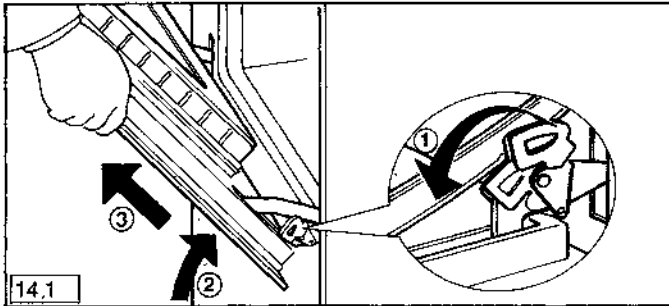

### ■ To re-insert the door:

1. Insert the door with both brackets into the oven.
2. Fold door downwards and turn back door catch (see illustration).

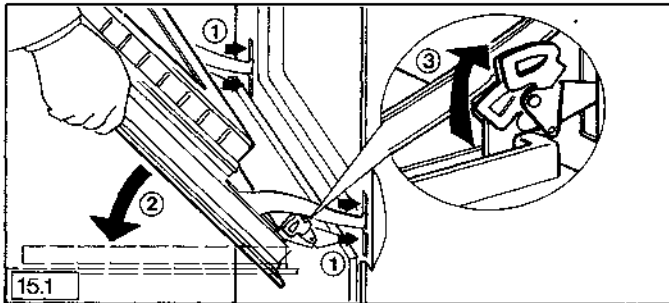

### Dismantling and installing the shelf grid

- Shelf grid  
To clean the side walls of the oven, the shelf grid (see illustration) can be taken out.

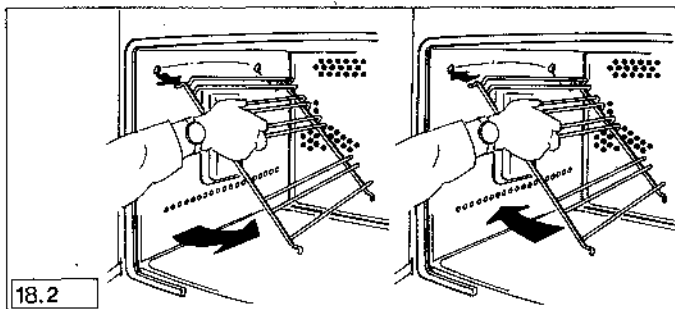

Pull the shelf grid inwards and then detach above.  
Re-insert in the reverse sequence.

### Cleaning the grease filter

- Grease filter  
Boil the **grease filter** in water with dishwasher cleaner or soft soap.

## Special accessories

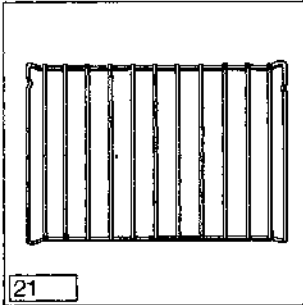

21  
Second grid to hold  
bakeware  
E-No.: 611 898 622

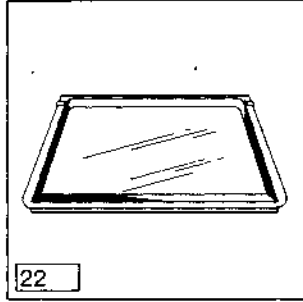

22  
Baking sheet  
E-No.: 611 898 620

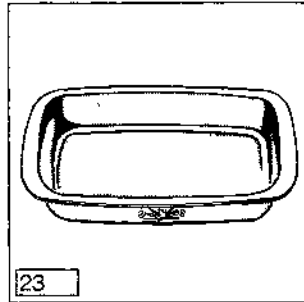

23  
Glass-ceramic roast pan  
(for placing on grid)  
E-No.: 611 898 660

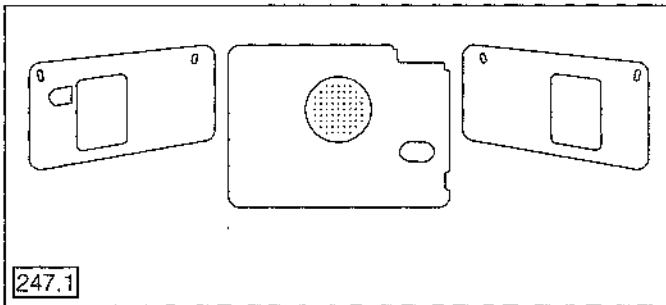

247.1  
Catalytic set KTG V  
E-No.: 611 898 607

## What to do if . . .

### **Faults you can rectify yourself**

... the pilot lamps do not show?

... the oven does not heat?

1. You may well have not operated all relevant switches or
2. the fuse on the fixed wiring side (safety box) has blown.
- 3. Important: Please make sure that my oven door is fully closed!**

... the fuses keep blowing?

Please call an approved electrical installer.

... the oven lighting fails?

**See Cleaning and care on page 120.**

**Failure of my oven lamp(s) does not fall under the guarantee.**

If, however, you decide to call in the service centre to help with any of the stated instructions or on grounds of faulty operation, the service engineer's visit cannot be made free of charge even during the guarantee period.

AEG electrical appliances comply with the valid safety requirements. Repairs to electrical appliances should only be performed by a trained electrician. Improper repairs may place the user at serious risk.



## Customer service

If you cannot find any reference to a particular fault in my operating instructions, please contact our service centre.

When doing so, quote the E-No. and F-No. of your oven, which you will find on my rating plate/arrow.

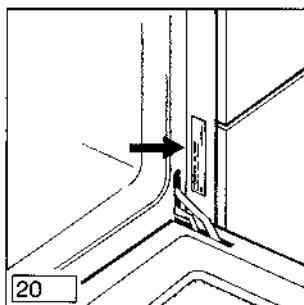

Your indication of these numbers enables the service centre to make precise identification of the required spare part so that I can be repaired at the engineer's first visit. You will thus save yourself additional costs due to any possible repeated trips by the service engineer.

So that these numbers are always to hand, you are recommended to enter them here.

**E-No.** .....

**F-No.** .....